

A Visit to the Hospital

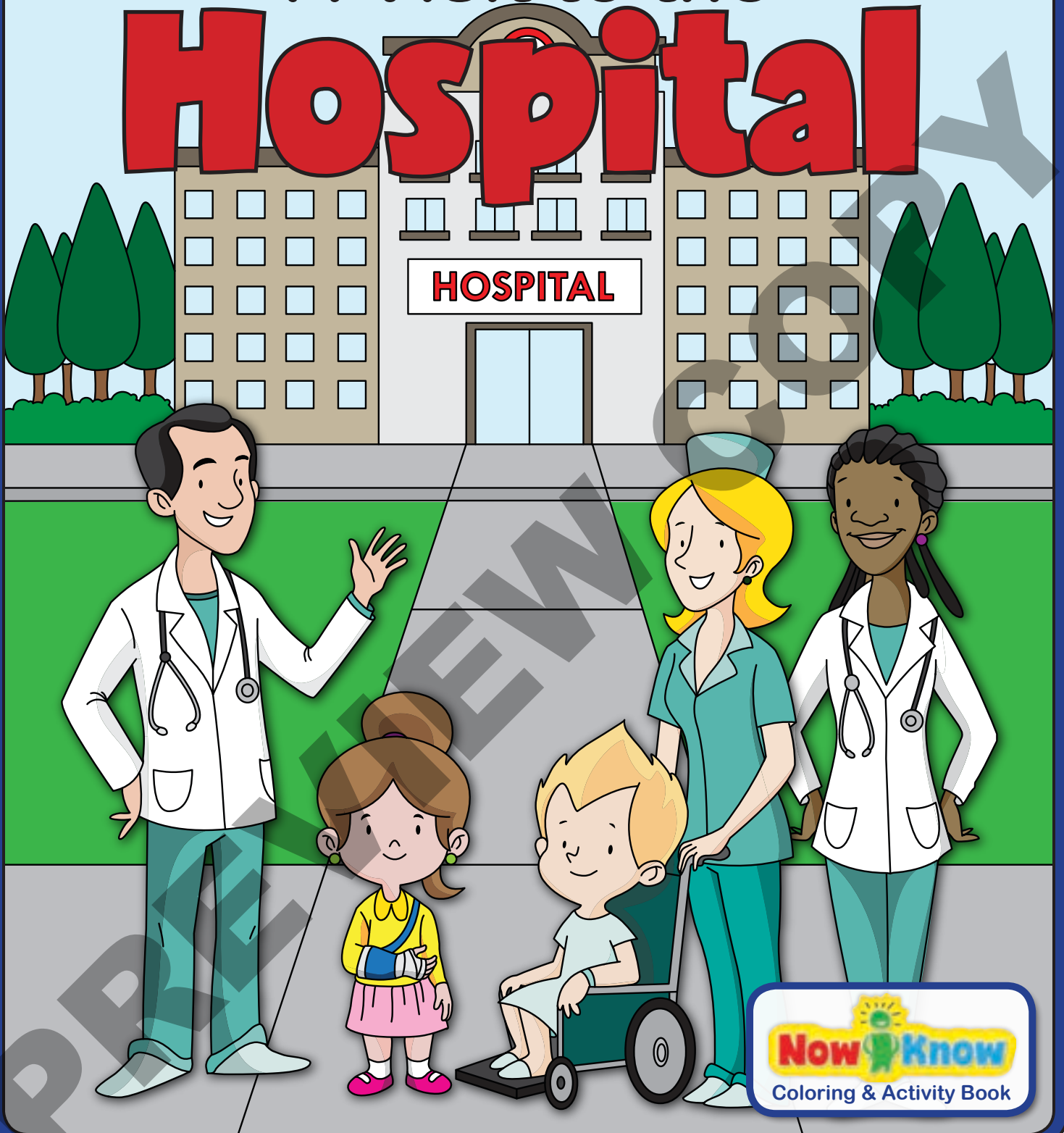

Now Know
Coloring & Activity Book

Why Do Kids Go To the Hospital?

Sometimes kids get **SICK**.

Hospitals help sick people get better. Kids go to the hospital when they have are really sick, not just for a cold or sore throat.

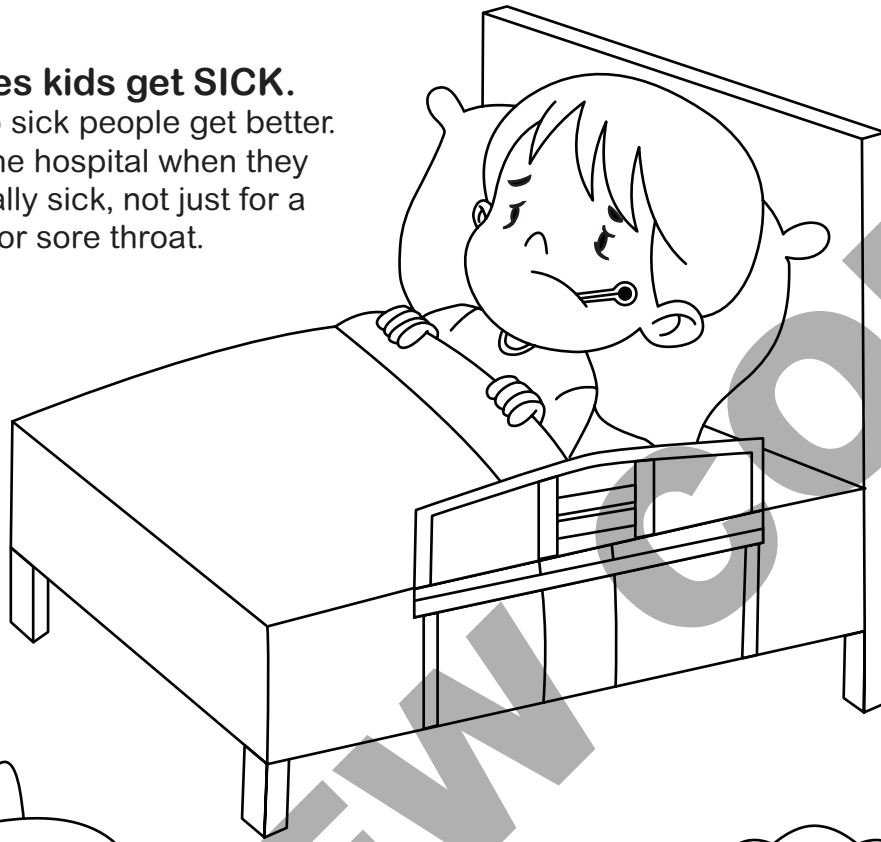

Kids have **ACCIDENTS**.

They may fall and break a bone, burn themselves, or hit their head. Any big injury is usually treated at the hospital.

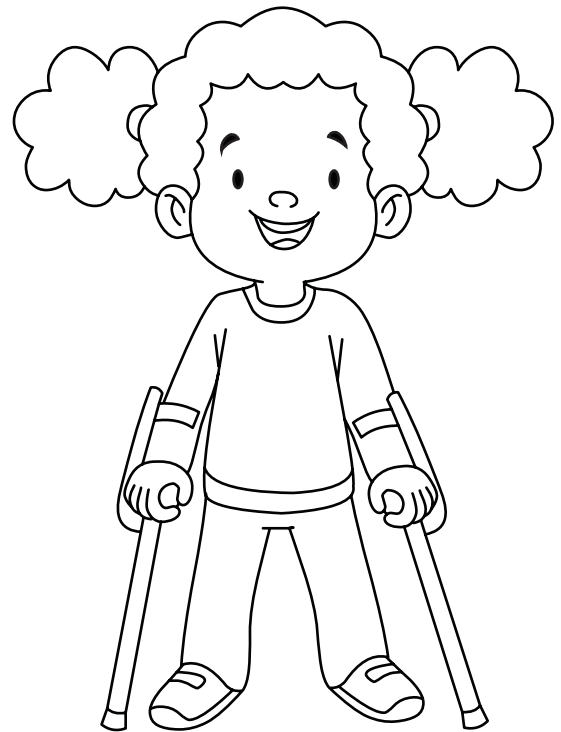

Some Kids Need **Extra Help**

Some kids are born with a part of them that doesn't work like it should or need extra help to feel better.

Who Will You Meet?

There are lots of people that help take care of you at the hospital. There are nurses, doctors, surgeons, and anesthesiologist just to name a few!

OPERATING ROOM

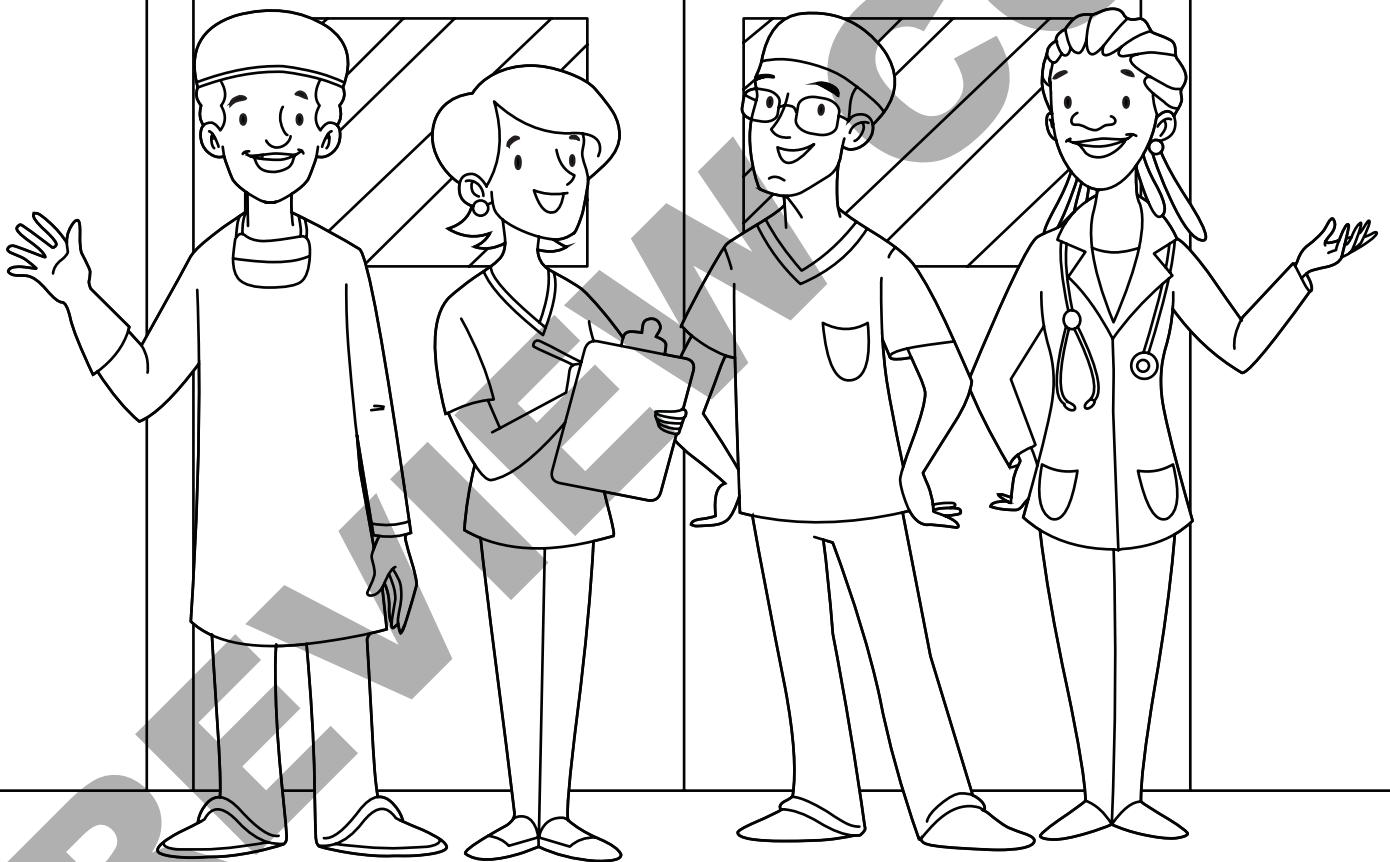

Medicine Mix Up!

Unscramble the words below to find out who and what you may see in the hospital.

URENS _ _ _ _ _

TSIHTECS _ _ _ _ _

CORDOT _ _ _ _ _

LAMNBUAGE _ _ _ _ _

R Y A X _ _ _ _

GRESUON _ _ _ _ _

Check In and Check Your Vitals!

When you get to the hospital they will check you in. You'll receive a hospital gown and bracelet. Then they will check your vital signs. Vital signs are measurements of different ways the body works.

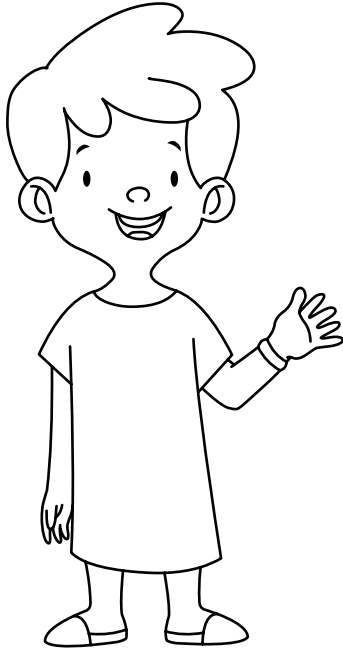

Give you a **GOWN**
and a **WRISTBAND**

Check your **HEIGHT**
and **WEIGHT**

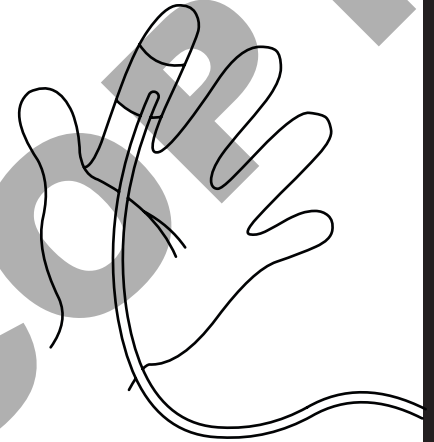
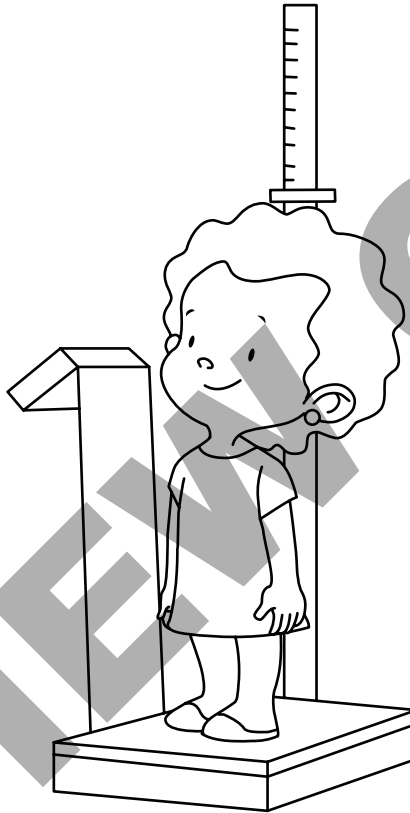

Check your
OXYGEN levels

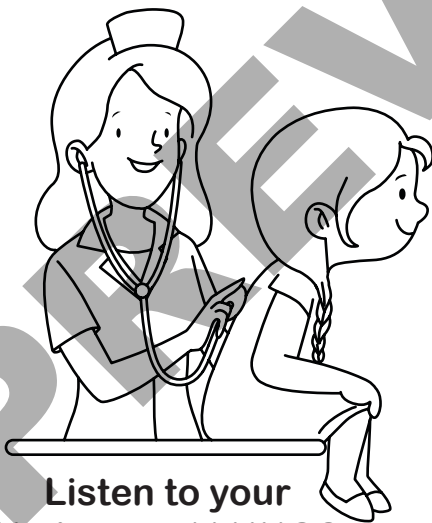

Listen to your
HEART and **LUNGS**

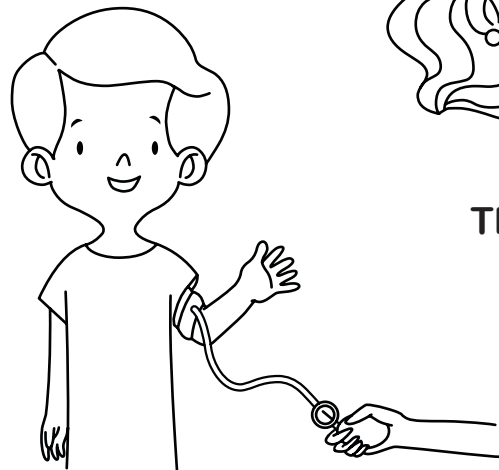

Check your
BLOOD PRESSURE



Check your
TEMPERATURE

A Doctor May Need To Run Special Tests

Sometimes a doctor needs to see **INSIDE** your body. The special tests below can let a doctor see different systems of your body. They don't hurt at all!

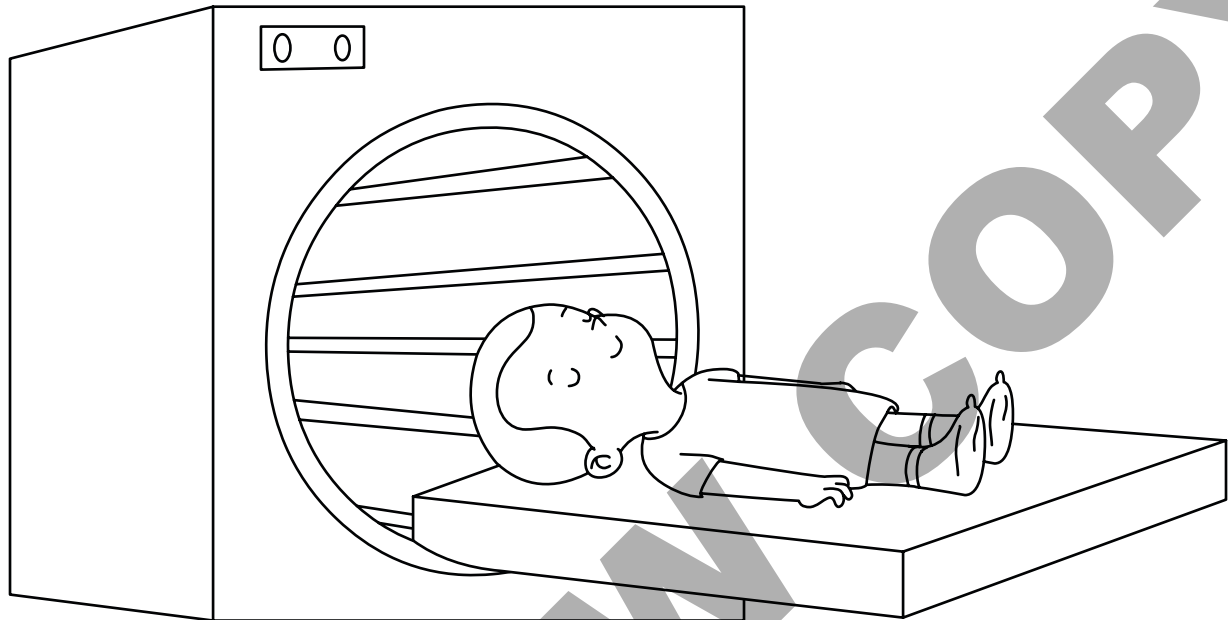

MRI Machine - uses magnets to take pictures of tissues and organs inside your body

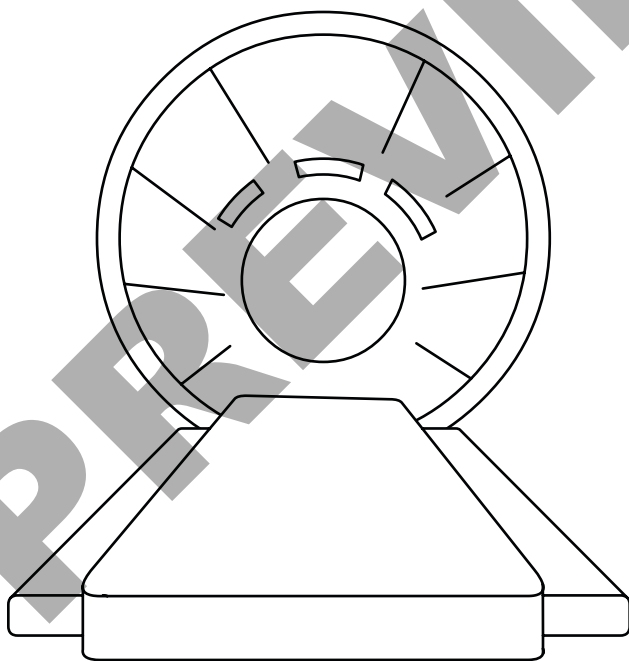

CT Scanner - uses multiple x-rays to see details of your bones and some organs

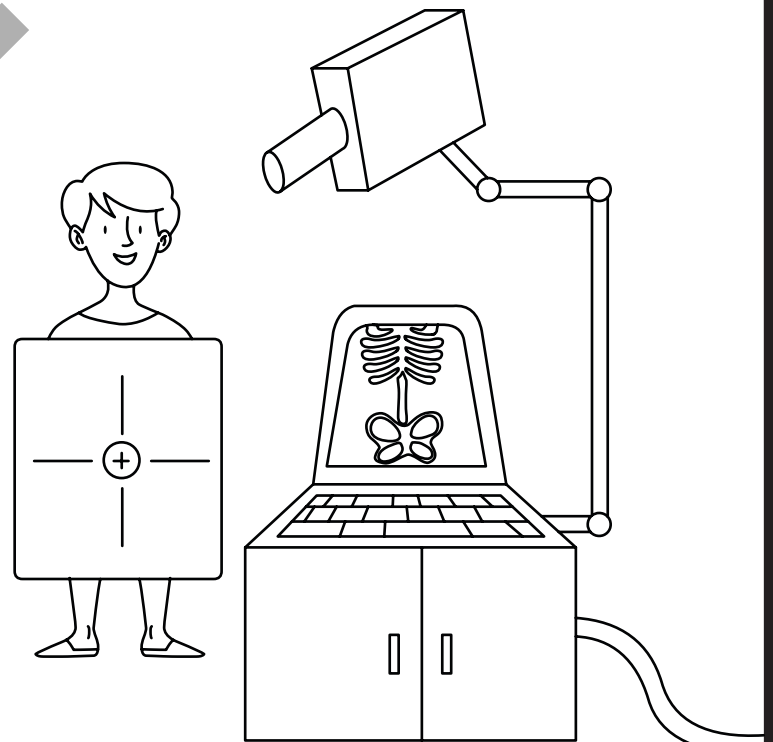

X-Ray Machine - takes pictures of your bones

How Do You Get To The Hospital?

Children get to the hospital in many different ways.
Can you find the ways to get to the hospital room?

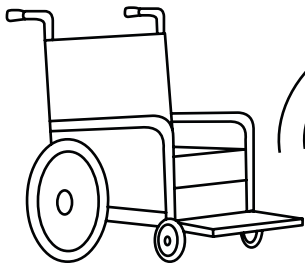

A **WHEELCHAIR** takes you from one part of the hospital to another.

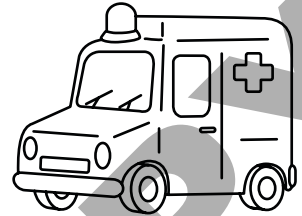

An **AMBULANCE** gets to the hospital **FAST**.

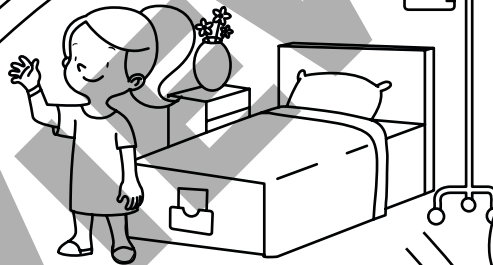

You can ride in your own **CAR**.



A **DOCTOR** may transfer you to the hospital from their office.

Name That Tool!

Doctors use all kinds of tools to make you healthy again. Draw a line from the picture to the description of the tools doctors at hospitals use every day.



IV BAG

Gives you medicine and fluids to make you feel better

AMBULANCE

Gets you to the hospital quickly

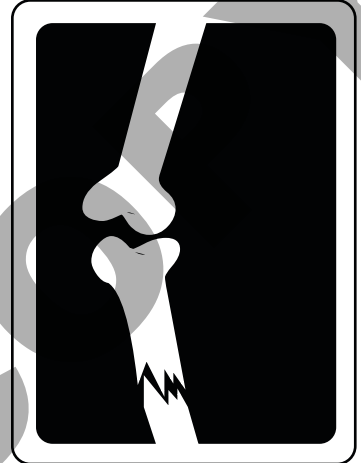

HOSPITAL BRACELET

Helps your doctor know who you are and why you are there

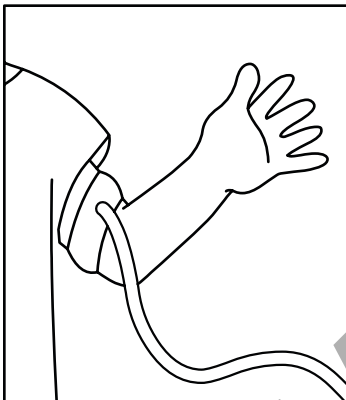

X-RAY

Takes a picture of your bones

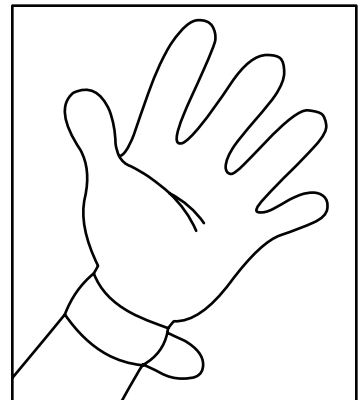

ANESTHESIA MASK

Helps you rest and go to sleep for a surgery

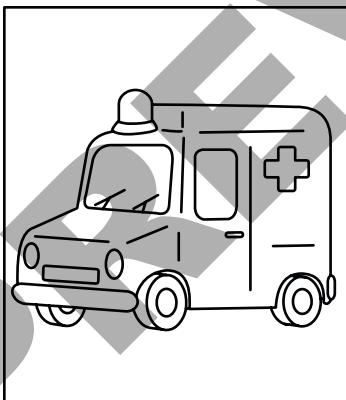

BLOOD PRESSURE CUFF

Measures how your blood flows

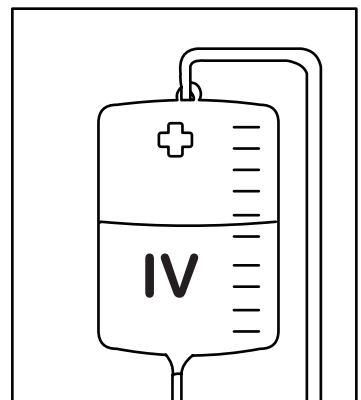

Tool Tip:

Hospitals are very careful to clean and sterilize their tools to keep us safe from germs.

EXIT

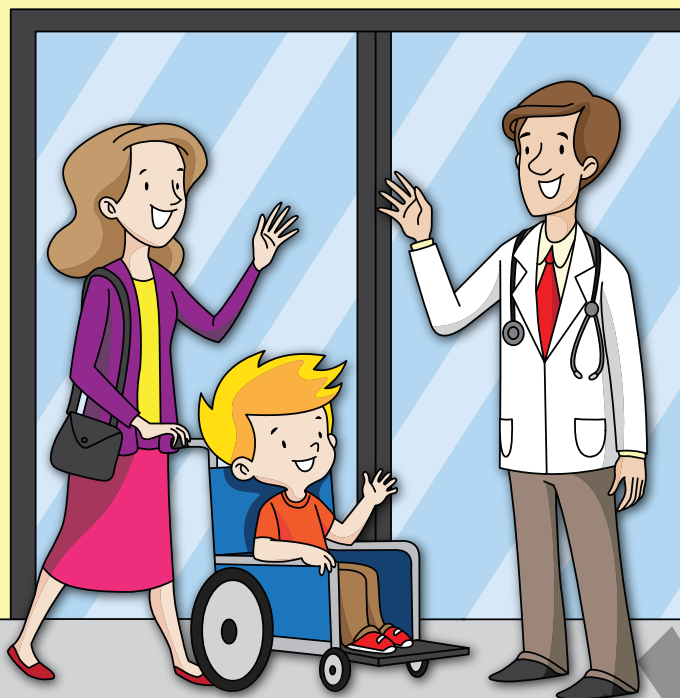

Remember To:

- Always follow your doctors discharge instructions
- Take any medicine that you were prescribed
- Make any follow up appointments with your regular doctor

Feel Better!

PREVIEW